

2144979N (Green Velvet), 2144779N (Pink Velvet), 2144479N (Gray Velvet),
2144879N (Light Green Velvet), 2144379N (Mustard Yellow Velvet),
2144679N (Blue Velvet), 2144209N (Camel PU),
2144149N (Ivory Boucle), 2144329N(Tan Basket Weave)

Memory Foam Futon

Weight Limit: 600 lb /272 kg

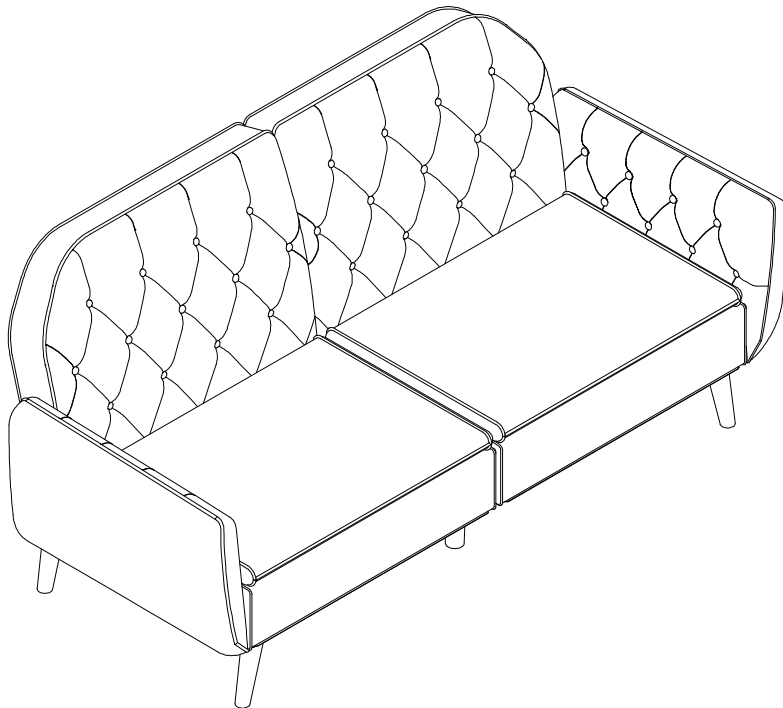

Missing or damaged parts? Concerns? Questions?

Do NOT return this product!

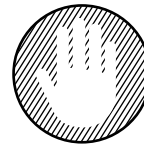

Contact us and we will gladly ship your replacement parts free of charge.

Visit our help center to contact our customer service team, find assembly videos, care instructions and more.

www.dorelhome.com/help/dhp
or call Toll-Free 1-800-267-1739

Leave a Review



We would love to hear from you

Simply search using the model number shown at the top of this page.



Scan to leave your review

Date of Purchase

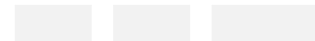

Lot Number (TAKEN FROM CARTON)

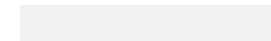

THIS INSTRUCTION BOOKLET CONTAINS **IMPORTANT** SAFETY INFORMATION. PLEASE READ AND KEEP FOR FUTURE REFERENCE.

C.V - 17/01/2025

B342144XXXN03CV

Limited 1 Year Warranty

Dorel Home warrants this product to be free from defects in material and workmanship and agrees to remedy any such defect. This warranty covers one year from the date of original purchase from authorized retailers. This is solely limited to the repair or replacement of defective parts and assembly labor is not included.

This warranty does not apply to any product which has been improperly assembled, subjected to misuse or abuse or which has been altered or repaired in any way. The warranty does not cover wearing, tearing, fading or splitting of the fabric (where applicable). Liability for consequential damages is excluded to the extent exclusion is permitted by law. This warranty gives you specific legal rights and you may also have other rights which vary from state to state or province to province.

To obtain warranty service, purchaser must present original bill or sale. Components repaired or replaced are warranted through the remainder of the original warranty period only. The defective components will be repaired or replaced without charge, subject to the terms and conditions described above.

The terms and conditions of the limited warranty and subject to change without notice. For the latest warranty policy, please visit www.dorelhome.com

Contact Us!

Visit our help center to find answers to all your questions.

www.dorelhome.com/help/dhp



Write to Us

DHP Consumer Services
12345 Albert Hudon, Suite 100
Montreal, Quebec
H1G 3L1



Chat With Us!



Email Us



Order Parts
Online



Watch Assembly
Videos

Read Before Beginning Assembly

- Work in a spacious area and near where the unit will be used, preferably on a carpet, or use a piece of the cardboard packaging to protect your floor and product.
- Make sure all parts are included. Most parts are labeled or stamped on the raw edge.
- Read each step carefully. It is very important that each step of the instructions is performed in the correct order. If these steps are not followed in sequence, assembly difficulties will occur.
- This product may contain small components. Please ensure that they are kept away from small children.
- This product is designed for home use and is not intended for commercial use.

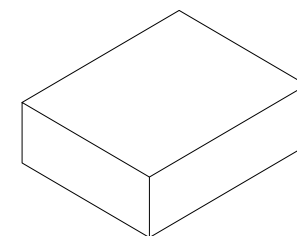
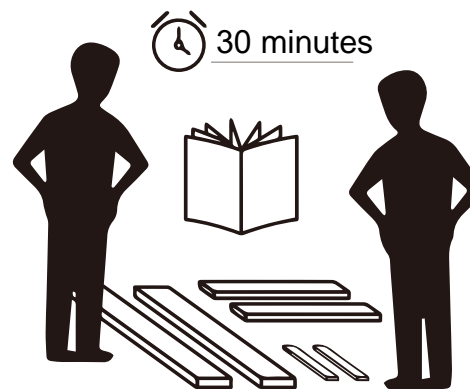

This product is shipped in
1 carton

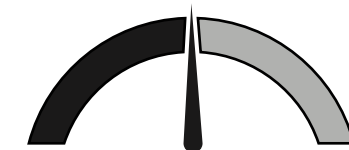

Easy Tough
Assembly Difficulty Meter

Tools required (not included)

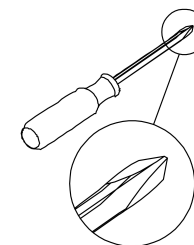

Phillips head
screwdriver

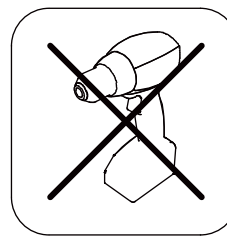

DO NOT use
powertools

Follow us @dorelhome

For updates on new products, promotions and more!



PARTS

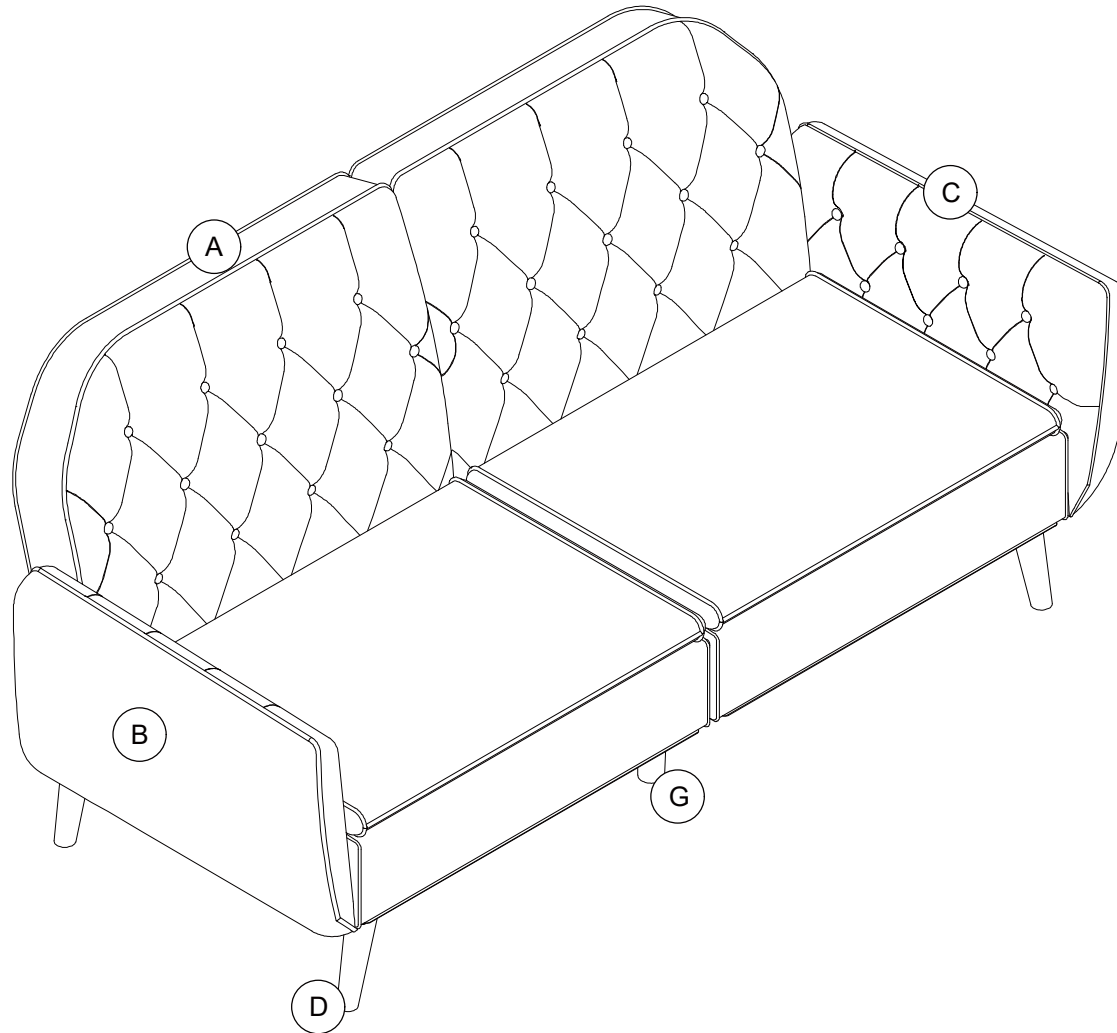

PARTS LIST

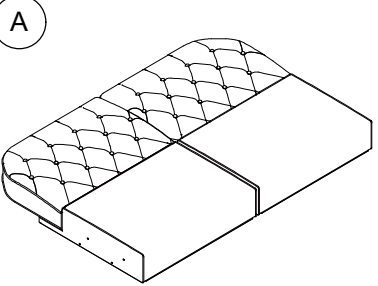
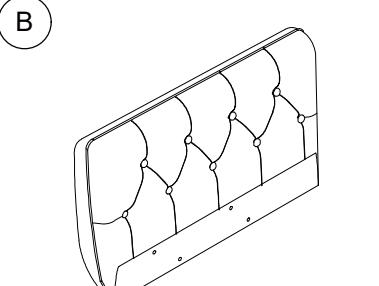
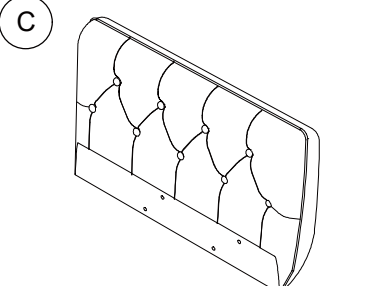
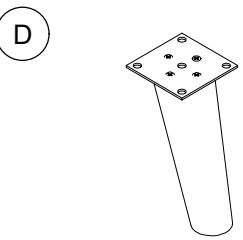
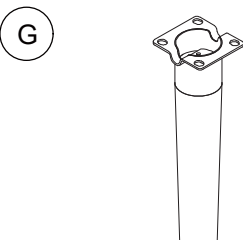
		
<p>Seat 1 PC</p>	<p>Left Arm 1 PC</p>	<p>Right Arm 1 PC</p>
		
<p>Leg 4 PCS</p>	<p>Middle Leg 2 PCS</p>	

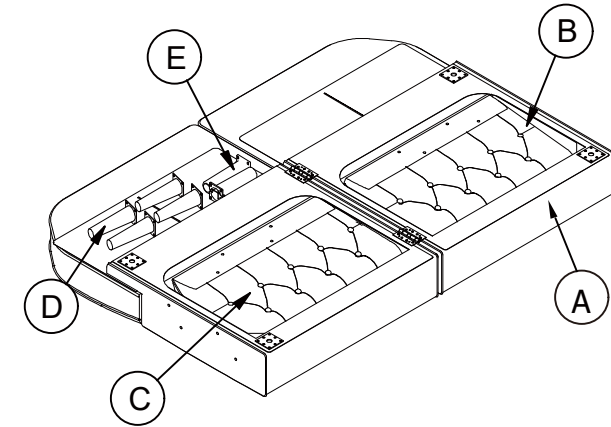

! The arms and legs will be found in the compartments under the seat shown.





! Each part has a unique part number. Please refer to the appropriate part number when contacting customer service for replacement parts.

! Before throwing any packaging, please verify all contents and make sure you have received all the parts listed above!

PART NUMBERS

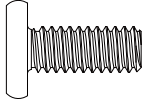
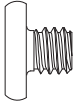
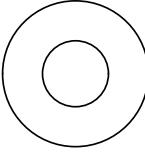
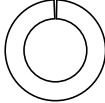
PART LABELS	2144979N (Green Velvet)	2144779N (Pink Velvet)	2144479N (Gray Velvet)	2144879N (Light Green Velvet)	2144379N (Mustard Yellow Velvet)	2144679N (Blue Velvet)	2144209N (Camel PU)	2144149N (Ivory Boucle)	2144329N (Tan Basket Weave)
A	/	/	/	/	/	/	/	/	/
B	T650510	T650550	T650570	T650590	T650610	T650630	T650650	T2144149N020CV	T2144329N020CV
C	T650520	T650560	T650580	T650600	T650620	T650640	T650660	T2144149N030CV	T2144329N030CV
D	T650530	T650530	T650530	T650530	T650530	T650530	T650530	T650530	T650530
G	T638670	T638670	T638670	T638670	T638670	T638670	T638670	T638670	T638670

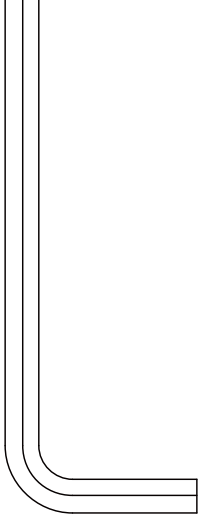
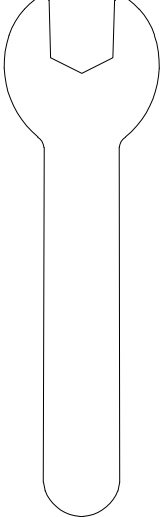
HARDWARE LIST

					
<p>5/16" X 120mm Bolt 8 PCS</p>	<p>1/4" X 3/5" Bolt 16 PCS</p>	<p>M6 X 6mm Bolt 8 PCS</p>	<p>5/16" Washer 8 PCS</p>	<p>5/16" Spring Washer 8 PCS</p>	<p>5/16" Nut 8 PCS</p>
			<p> Please do not completely tighten all the hardware, until the entire assembly is complete, unless otherwise indicated in the step-by-step instructions.</p> <p> The screw(s), bolt(s) to be used at each step are shown in actual size in the lower right corner of the page.</p>		
	<p>4mm L-Allen Key 1 PC</p>	<p>Wrench 1 PC</p>			

Hardware Pack

2144979N (Green Velvet)	2144679N (Blue Velvet)	 HP #:22144XXXN0CV
2144779N (Pink Velvet)	2144209N (Camel PU)	
2144479N (Gray Velvet)	2144379N (Mustard Yellow Velvet)	
2144879N (Light Green Velvet)		
2144149N (Ivory Boucle)		
2144329N (Tan Basket Weave)		

Step 1

Open the zippers under the compartment of **A** and take out the hidden components.

Hand tighten **1** into **B** & **C** as shown.

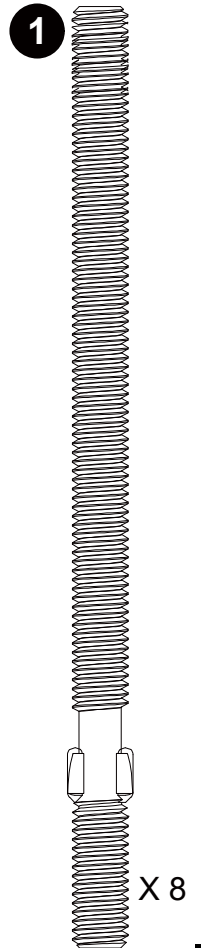
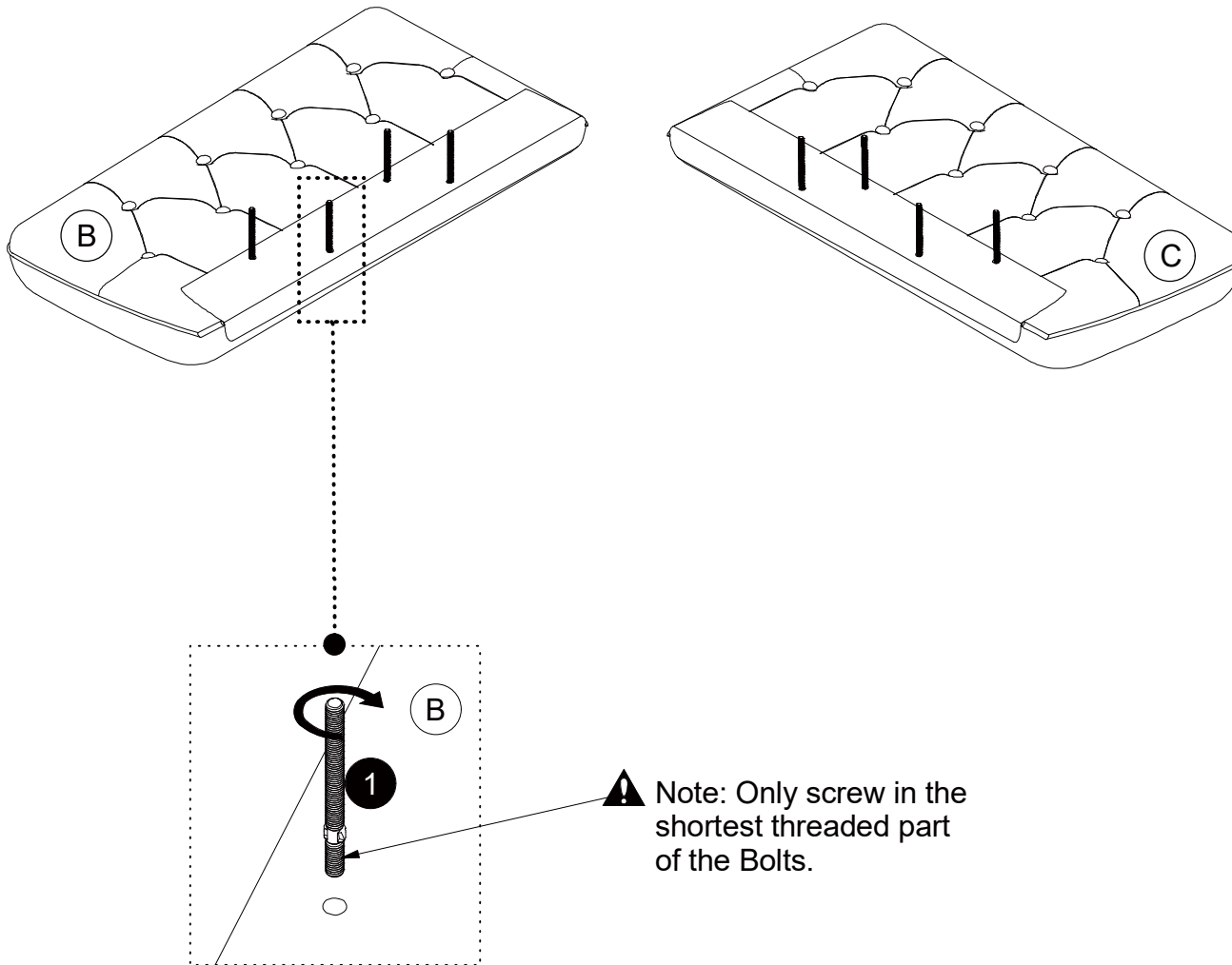

Step 2

Attach **B** & **C** to **A** with **4**, **5** and **6** as shown.

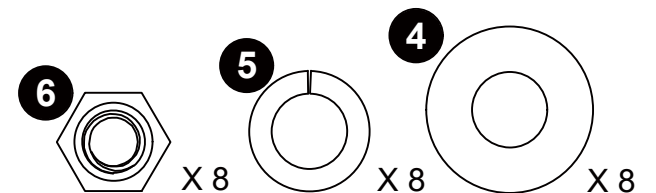
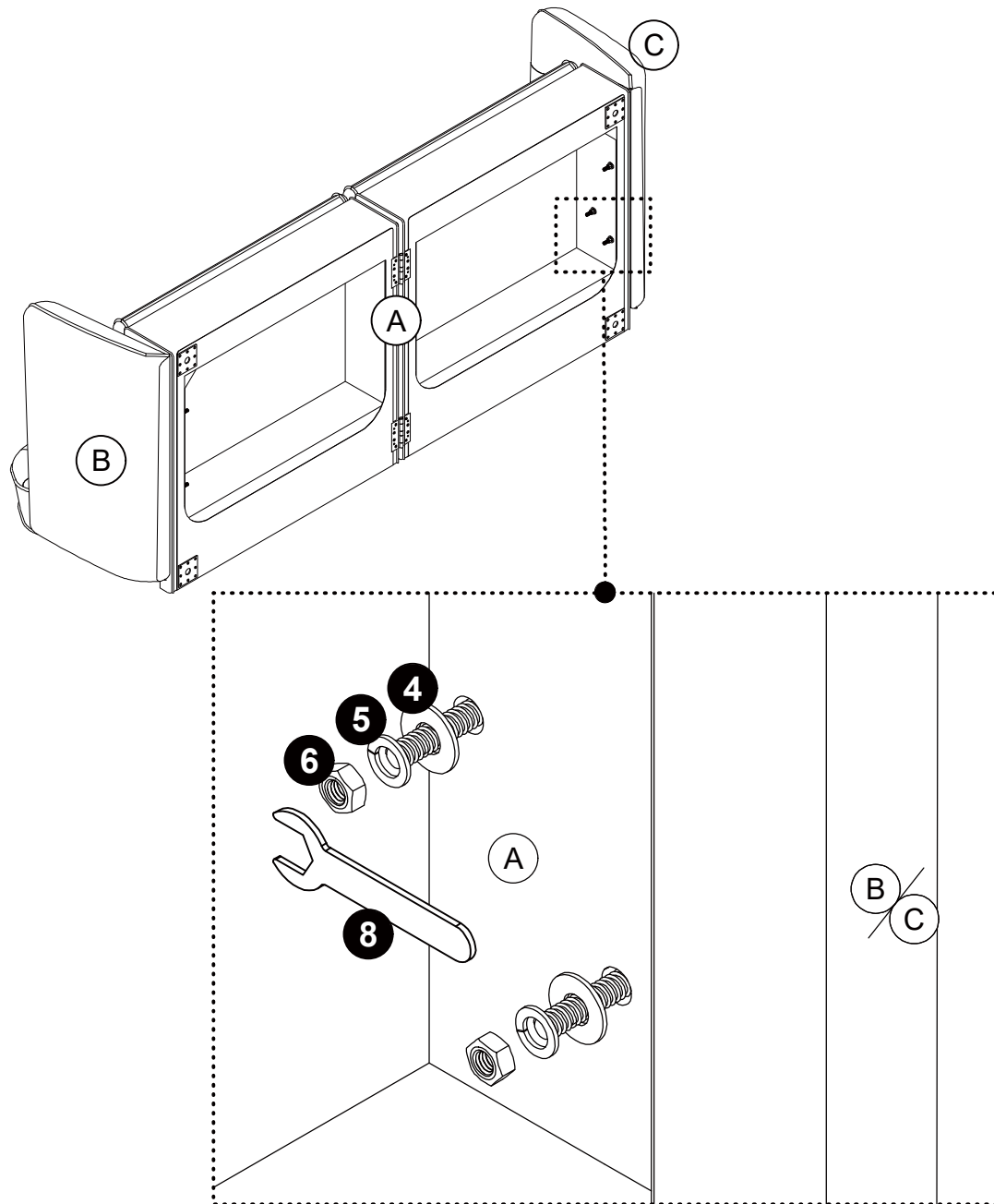

Step 3

Attach **D x 4** to **A** with **2** as shown.

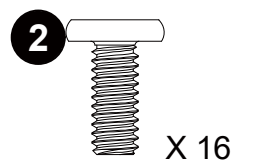
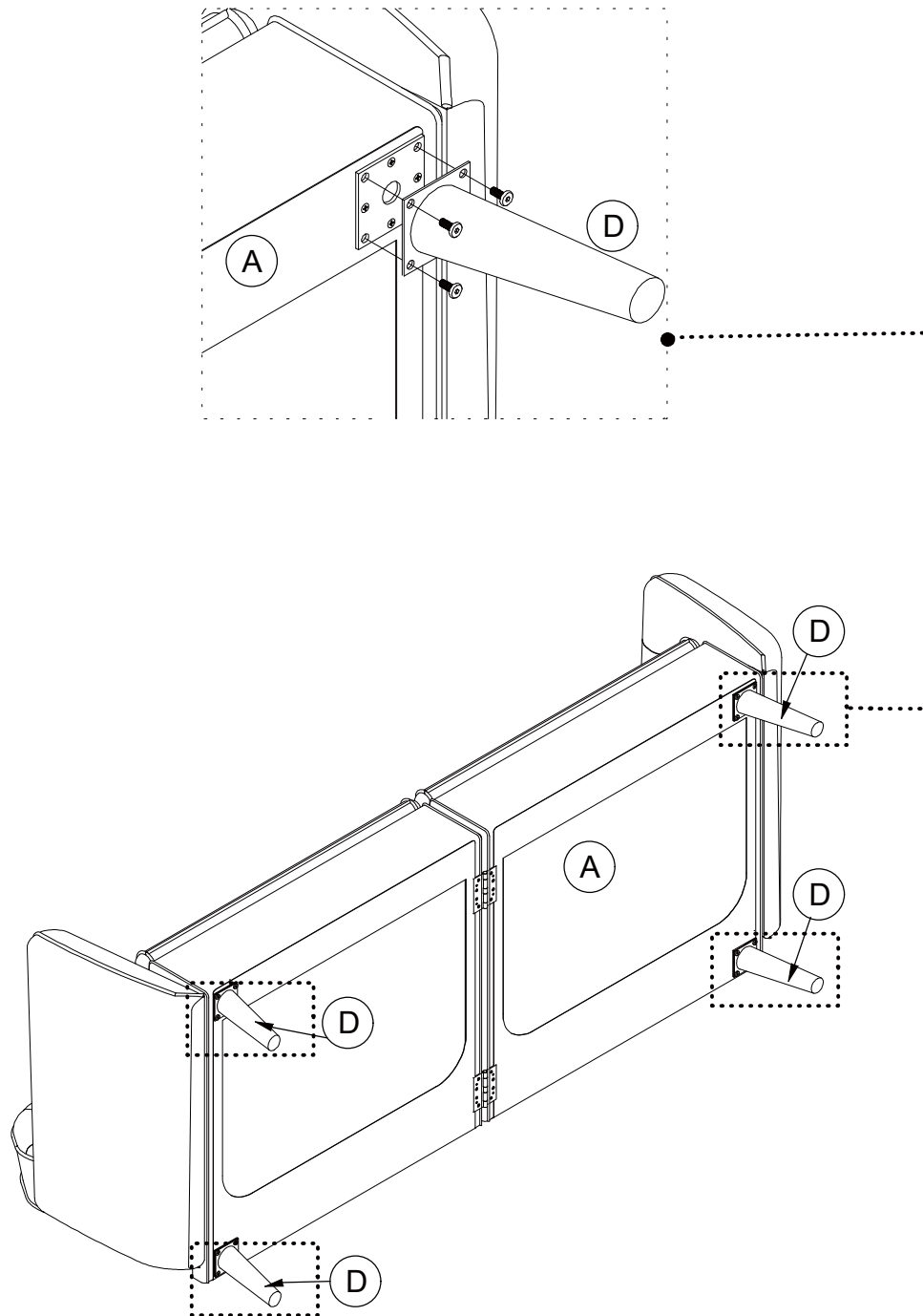

Step 4

Attach **G** x 2 to **A** with **3** as shown.

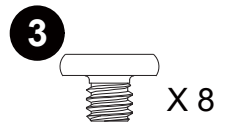
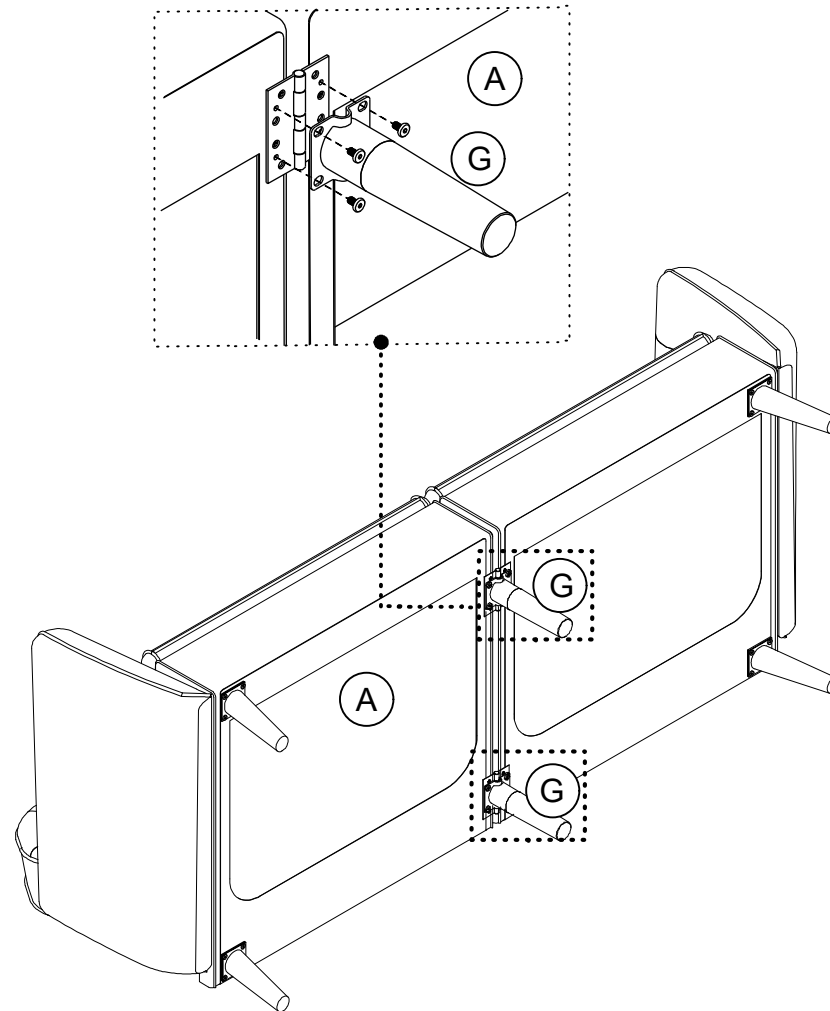

⚠ CAUTION: This unit is intended for use only with the products and/or maximum weights indicated. Use with other products and/or products heavier than the maximum weights indicated may result in instability or cause possible injury.

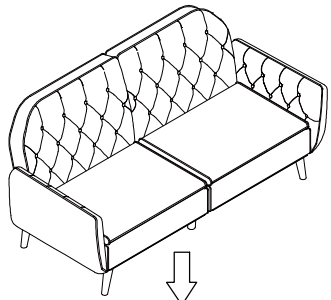

⚠ Caution: Open hidden support leg when change to bed function.

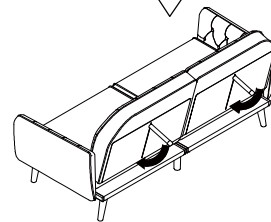
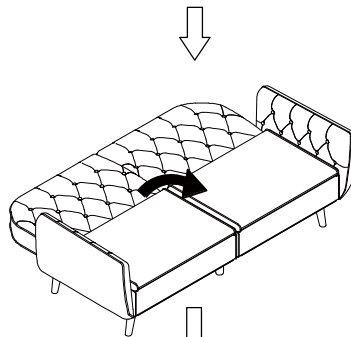
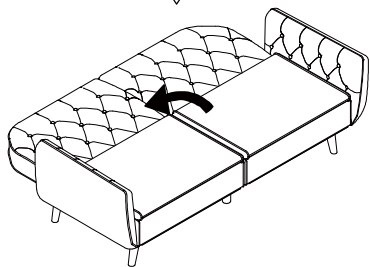
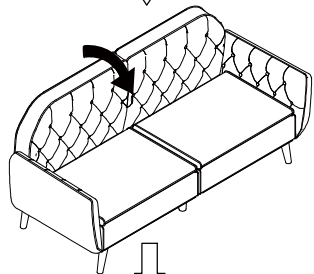
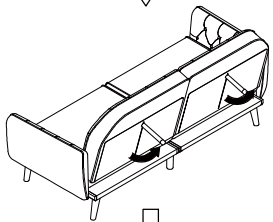

Support Leg
T616300
X 2

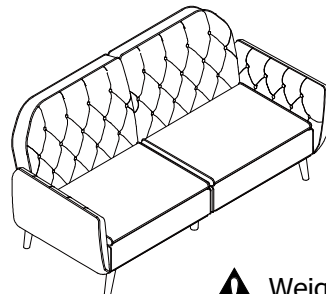

⚠ Weight Limit: 600lb / 272kg

Step 5

Leave a Review ★★★★★

We would love to hear from you
Simply search using the model number
shown at the top of this page.



Scan to leave your review

Helpful Hints

- Move your new furniture carefully, with two people lifting and carrying the unit to its new location.
- Your furniture can be disassembled and reassembled to move.
- Clean the product with a soft damp cloth. DO NOT use harsh chemicals or abrasive cleaners.
- Check bolts and nuts periodically and tighten if necessary.
- Some parts have been pre-assembled for this item. They are illustrated on this page and available for replacement.
- To convert from sofa position to bed position: Pull the backrest in direction of the arrow as far as possible and then release, as shown.

That's it ! You've finished assembling your **Memory Foam Futon!**

2144979N (Terciopelo verde), 2144779N (Terciopelo rosa),
2144479N (Terciopelo Gris), 2144879N (Terciopelo verde claro),
21444379N (Terciopelo amarillo mostaza),
2144679N (Terciopelo azul), 2144209N (Camello PU),
2144149N (Pudín de Marfil), 2144329N (Marrón Tejido de canasta)

Futón de espuma viscoelástica

Fecha de compra

Número de lote

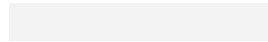
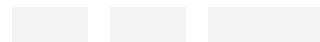

¡Gracias por tu compra Dorel Home! Información sobre la garantía

Dorel Home garantiza que este producto está libre de defectos de material y mano de obra y se compromete a remediar cualquier defecto de este tipo. Esta garantía cubre 1 año a partir de la fecha de compra original. Esta garantía es válida solamente con presentación de una prueba de compra. Esto se limita a la reparación o reemplazo de componentes defectuosos del mueble y no se incluye ningún trabajo de ensamblaje.

Esta garantía no se aplica a ningún producto que haya sido mal ensamblado, sujeto a mal uso o abuso, o que haya sido alterado o reparado de cualquier manera. Cualquier uso, rotura o pérdida de color de la tela no están incluidos en esta garantía (donde corresponda). Esta garantía le da derechos legales específicos y usted puede también tener otros derechos que varían de estado a estado o de provincia a provincia.

Para obtener el servicio de garantía, debe presentar la factura original de su compra. Los componentes reparados o reemplazados están garantizados durante el periodo original de la garantía. Las partes defectuosas serán reparadas o reemplazadas sin cargo extra y sujetas a los términos y condiciones descritos anteriormente. Los términos y condiciones de la garantía limitada están sujetos a cambios sin previo aviso. Para conocer la política de garantía más reciente, visite www.dorelhome.com

Precauciones

- Este producto está diseñado para uso doméstico y no para uso comercial.
- ADVERTENCIA PARA NIÑOS PEQUEÑOS - Este producto contiene componentes pequeños. Por favor asegúrese de que las piezas estén fuera del alcance de los niños.
- No utilice herramientas eléctricas para ensamblar su mueble. Este tipo de herramientas pueden rasgar o dañar las partes.

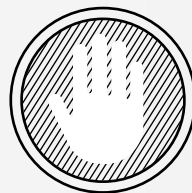

Preguntas, inquietudes, partes que faltan? **CONTACTE NUESTRO DEPARTAMENTO DE SERVICIO AL CLIENTE ANTES DE DEVOLVER EL PRODUCTO A LA TIENDA.**

Si le faltan piezas o las que se incluyen están dañadas, con mucho gusto le enviaremos sus piezas de reemplazo sin cargo extra.

Visite www.dorelhome.com/help/dhp
llame gratis al 1-800-267-1739



ESTE INSTRUCTIVO CONTIENE **INFORMACION** IMPORTANTE DE SEGURIDAD. PAR FAVOR LEA Y GUARDE PARA SU REFERENCIA FUTURA.

Lea antes de comenzar a ensamblar

Llame a nuestro número gratuito si necesita asistencia.

Trabaje en un área espaciosa y cerca de donde su producto será utilizado, preferiblemente sobre una alfombra o utilice el cartón del empaque para proteger su piso y su producto.

El número de personas recomendadas para el montaje de este producto es: 2 (sin embargo es recomendable contar con ayuda adicional).

Tiempo estimado de ensamble es: 30 minutos.

Asegúrese de que todas las partes están incluidas. La mayoría de las partes están etiquetadas o selladas en los bordes.

Lea cada paso cuidadosamente. Es muy importante que cada paso de las instrucciones sea realizado en el orden correcto. Si estos pasos no se siguen en secuencia, pueden ocurrir dificultades durante el ensamblado.

¡Contáctenos!

Visita nuestro centro de ayuda para encontrar respuestas a todas tus preguntas www.dorelhome.com/help/dhp



Chatea con nosotros



Envíanos un correo electrónico



Ver videos de montaje



Pedir piezas en línea



Escríbenos:
DHP Customer Service
12345 Albert Hudon, Suite 100
Montreal, Quebec
H1G 3L1

Déjanos una reseña





Escanea para dejar tu reseña

Partes

Piezas de reemplazo, visite www.dorelhome.com/help/dhp

IMPORTANTE: La lista de números de piezas que aparece a continuación es exclusiva de su producto. Por favor, manténgalo a mano cuando solicite piezas de repuesto.

 Todo se incluye en 1 caja(s) grande(s)!

 Antes de deshacerse de las cajas de cartón, asegúrese de que estén vacías. También confirme que ha recibido todos los componentes necesarios para el ensamblaje al compararlos con la tabla de piezas indicadas en la sección en inglés.

Paquete de componentes

 **Nota:** Por favor apriete completamente los pernos durante el ensamblaje, apriételos en la última etapa del ensamblaje, a menos que este indicado específicamente en alguna etapa de las instrucciones.

 Los tornillo(s), perno(s) que se utilizan en cada paso se muestran en tamaño real en la esquina inferior derecha de cada página.

NÚMERO DE PIEZAS

ETIQUETAS DE PIEZAS	DESCRIPTION	2144979N (Terciopelo verde)	2144779N (Terciopelo rosa)	2144479N (Terciopelo Gris)	2144879N (Terciopelo verde claro)	2144379N (Terciopelo amarillo mostaza)	2144679N (Terciopelo azul)	2144209N (Camello PU)	2144149N (Pudín de Marfil)	2144329N (Marrón Tejido de canasta)
A	Asiento	/	/	/	/	/	/	/	/	/
B	Brazo izquierdo	T650510	T650550	T650570	T650590	T650610	T650630	T650650	T2144149N020CV	T2144149N020CV
C	Brazo derecho	T650520	T650560	T650580	T650600	T650620	T650640	T650660	T2144149N030CV	T2144149N030CV
D	Pierna	T650530	T650530	T650530	T650530	T650530	T650530	T650530	T650530	T650530
G	Pierna media	T638670	T638670	T638670	T638670	T638670	T638670	T638670	T638670	T638670

2144979N (Terciopelo verde)	2144679N (Terciopelo azul)	 HP #:22144XXXN0CV
2144779N (Terciopelo rosa)	2144209N (Camello PU)	
2144479N (Terciopelo Gris)	2144379N (Terciopelo amarillo mostaza)	
2144879N (Terciopelo verde claro)		
2144149N (Pudín de Marfil)		
2144329N (Marrón Tejido de canasta)		

Instrucciones

Paso 1

Abra las cremalleras de los compartimentos de **A**, saque todos los componentes contenidos, cierre las cremalleras.

Apriete a mano **1** en **B** y **C** como se muestra.

Paso 2

Una **B** & **C** con **A** usando **4**, **5** y **6** como se muestra.

Paso 3

Una **D** x 4 con **A** usando **2** como se muestra.

Paso 4

Una **G** x 2 con **A** usando **3** como se muestra.

 Límites de peso: 600 lb / 272 kg

Consejos útiles

- Su futón puede cambiar de posición de sofá a la posición de cama.
- Mueva sus muebles nuevos con cuidado, se requiere de dos personas para levantar y trasladar su mueble a su nueva ubicación.
- Sus muebles se pueden desmontar y volver a ensamblar en caso de mudanza.
- Limpie el producto con un paño suave. NO utilice productos químicos o abrasivos de limpieza.
- Algunas partes han sido pre-ensambladas en este producto. Se encuentran ilustradas en esta página (sección en inglés) y disponibles para reemplazo .

PRECAUCIÓN

Esta unidad está diseñada para ser utilizada únicamente con los productos y/o pesos máximos indicados. Su uso con otros productos y/o productos más pesados que los pesos máximos indicados puede provocar inestabilidad o causar lesiones.

2144979N (Velours vert), 2144779N (Velours Rose),
2144479N (Velours gris), 2144879N (Velours Vert Clair),
21444379N (Velours jaune moutarde),
2144679N (Velours bleu), 2144209N (Chameau PU),
2144149N (Boucle Ivoire), 2144329N (Tan panier Weave)

Futon en mousse à mémoire de forme

Date d'achat

Numéro de lot

Merci d'avoir acheté un produit Dorel Home Informations sur la garantie

Dorel Home garantit que ce produit est exempt de tout vice de matériaux et de fabrication et s'engage à remédier à un tel défaut. Cette garantie est valable un an à compter de la date d'achat initiale. Elle se limite uniquement à la réparation ou au remplacement des pièces défectueuses. La main-d'oeuvre nécessaire à l'assemblage n'est pas incluse.

Cette garantie ne s'applique pas aux produits qui ont été mal assemblés, qui ont été soumis à une utilisation abusive ou qui ont subi des modifications ou des réparations du tissu (le cas échéant). La responsabilité pour les dommages indirects est exclue quant l'exclusion est autorisée par la loi. Cette garantie vous confère des droits spécifiques légaux. Il se peut que vous bénéficiiez de droits additionnels car ceux-ci peuvent varier selon l'État ou la province.

Pour bénéficier du service de garantie, l'acheteur doit présenter la facture originale. Les composants réparés ou remplacés sont garantis jusqu'à la fin de la période de la garantie initiale uniquement. Les composants défectueux seront réparés ou remplacés sans frais, sous réserve des conditions décrites ci-dessus. Les termes et conditions de la garantie limitée sont susceptibles d'être modifiés sans préavis. Pour connaître la dernière politique de garantie, veuillez consulter le site www.dorelhome.com/fr

Précautions

- Ce produit est conçu pour un usage domestique et n'est pas destiné à des fins commerciales.
- **AVERTISSEMENT CONCERNANT LES JEUNES ENFANTS:** Ce produit contient des petits composants. S'il vous plaît assurez-vous qu'ils soient gardés loin d'eux.
- Ne pas utiliser d'outils électriques pour assembler votre mobilier. Ce type d'outils risque d'endommager les pièces.

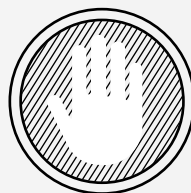

Des questions, des préoccupations ou des pièces manquantes? **CONTACTEZ NOTRE SERVICE À LA CLIENTÈLE AVANT DE RETOURNER LE PRODUIT AU DÉTAILLANT**

Si des pièces sont manquantes ou endommagées, nous expédierons volontiers vos pièces de rechange gratuitement.

Visitez www.dorelhome.com/help/dhp/fr
ou appelez sans frais au 1-800-267-1739



CE FEUILLET CONTIENT DES INFORMATIONS DE SÉCURITÉ **IMPORTANTES**. S'IL VOUS PLAÎT LIRE ET CONSERVER POUR RÉFÉRENCE ULTÉRIEURE.

Avant de commencer l'assemblage

- Si vous avez besoin d'aide, appelez notre service à clientèle sans frais.
- Travaillez dans un endroit spacieux et près du lieu où l'unité sera utilisée, préférablement sur un tapis, ou sur un morceau de l'emballage, afin de protéger le plancher et le produit.
- **Nombre de personnes recommandés pour l'assemblage: 2** (cependant il est toujours préférable d'être assisté par une personne supplémentaire).
- **Temps d'assemblage estimé: 30 minutes.**
- Assurez-vous d'avoir bien reçu toutes les pièces. La plupart de celles-ci sont étiquetées ou estampées sur leur côté non fini.
- Lisez attentivement chaque étape avant de débiter. Il est très important que chaque étape de montage soit exécutée dans le bon ordre, sinon vous risquez d'éprouver de la difficulté à assembler votre meuble.

Contactez-nous!

Besoin d'aide pour assembler, identifier des pièces, vous informer sur le produit, ou pour commander des pièces

Contactez-nous: www.dorelhome.com/help/dhp/fr



Clavardez avec nous



Envoyez-nous un email



Visualisez des vidéos d'assemblage



Commandez des pièces



Écrivez-nous
DHP Service à la Clientèle
12345 Albert Hudon, Suite 100
Montreal, Quebec
H1G 3L1

Laissez-nous un avis





Scannez pour laisser votre avis

Pièces

Pour des pièces de rechange, visitez www.dorelhome.com/help/dhp/fr

IMPORTANT: La liste des références ci-dessous est propre à votre produit. Veuillez l'avoir sous la main lorsque vous appelez pour des pièces de rechange.

 Tout dans **1** grande(s) boîte(s)!

 Avant de jeter les boîtes en carton, assurez-vous qu'elles soient vides. Vérifiez que vous avez reçu tous les composants nécessaires à l'assemblage en les comparant avec le tableau des pièces (illustrations disponibles dans la section en anglais).

Quincaillerie

 **Remarque:** Sauf indication contraire dans les instructions, ne pas resserrer complètement les vis et les boulons, jusqu'à ce que l'assemblage soit terminé.

 Les vis et boulons utilisés durant chaque étape sont illustrés en taille réelle au coin inférieur droit de la page.

LISTE DES PIÈCES

ÉTIQUETTE DES PIÈCES	DESCRIPTION	2144979N (Velours vert)	2144779N (Velours Rose)	2144479N (Velours gris)	2144879N (Velours Vert Clair)	2144379N (Velours jaune moutarde)	2144679N (Velours bleu)	2144209N (Chameau PU)	2144149N (Boucle Ivoire)	2144329N (Tan panier Weave)
A	Siège	/	/	/	/	/	/	/	/	/
B	Bras gauche	T650510	T650550	T650570	T650590	T650610	T650630	T650650	T2144149N020CV	T2144149N020CV
C	Bras droit	T650520	T650560	T650580	T650600	T650620	T650640	T650660	T2144149N030CV	T2144149N030CV
D	Jambe	T650530	T650530	T650530	T650530	T650530	T650530	T650530	T650530	T650530
G	Jambe médiane	T638670	T638670	T638670	T638670	T638670	T638670	T638670	T638670	T638670

2144979N (Velours vert)	2144679N (Velours bleu)	 HP #:22144XXXN0CV
2144779N (Velours Rose)	2144209N (Chameau PU)	
2144479N (Velours gris)	2144379N (Velours jaune moutarde)	
2144879N (Velours Vert Clair)		
2144149N (Boucle Ivoire)		
2144329N (Tan panier Weave)		

Instructions

Étape 1

Ouvrez les fermeture éclair des compartiments de **A**, retirez tous les composants contenus, fermez les fermetures éclair. Serrez à la main les ❶ autant que possible dans **B** et **C** tel qu'illustré.

Étape 2

Attacher **B** & **C** à **A** avec ❷, ❸ et ❹ tel qu'illustré.

Étape 3

Visser **D** x 4 à **A** avec ❺ tel qu'illustré.

Étape 4

Visser **G** x 2 à **A** avec ❻ tel qu'illustré.

 Limite de Poids: 600 lb / 272 kg

Conseils utiles

- Votre futon peut être transformé de Sofa en Lit.
- Déplacez votre nouveau mobilier avec soin, nous recommandons deux personnes pour soulever et transporter le mobilier vers son nouvel emplacement.
- Votre mobilier peut être démonté et reassemblé pour faciliter les déménagements.
- Nettoyez le produit avec un chiffon doux. NE PAS utiliser de *produits chimiques* ou abrasifs.
- Certaines pièces ont été préassemblées pour ce produit. Elles sont illustrées sur cette page (section en anglais) et sont disponibles pour un remplacement .

AVERTISSEMENT

Cette unité est destinée à être utilisée uniquement avec les produits et/ou les poids maximum indiqués. L'utilisation avec d'autres produits et/ou des produits plus lourds que les poids maximum indiqués peut rendre le meuble instable ou provoquer des blessures.